

TWISTED SMASH COPRODUCTS IN BRAIDED MONOIDAL CATEGORIES

Wenzheng Zhao, Shengjie Gao, Tianshui Ma

Received: 7 November 2008; Revised: 12 October 2009
Communicated by Abdullah Harmanci

ABSTRACT. Let $A \times_r H$ be a twisted smash coproduct for a bicomodule coalgebra A by a Hopf algebra H in a braided monoidal category. The smash coproduct in a braided monoidal category is the special case of $A \times_r H$. Moreover, we find a necessary and sufficient condition for $A \times_r H$ to be a bialgebra.

Mathematics Subject Classification (2000): 16W30

Keywords: braided monoidal categories, twisted smash coproducts, braided Hopf algebras, braided bicomodule coalgebras

1. Introduction

Braided monoidal categories were introduced by A. Joyal and R. Street in 1986 [4]. It is a generalization of super case. S. Majid, A. Joyal, R. Street and V. Lyubasheko have obtained many interesting conclusions in braided monoidal categories, for example, the braided reconstruction theorem, transmutation and bosonisation, integral, q -Fourier transform, q -Mikowski space, random walk and so on, see [7,9,10,11,12]. In the category of usual vector spaces with usual twist braiding, R. G. Heyneman and M. E. Sweedler introduced the definition and basic properties of the smash coproduct of A by H in [3], R.K. Molnar gave the sufficient condition for the smash coproducts to become bialgebras in [19, Theorem 2.14]. S. H. Wang and J. Q. Li introduced twisted smash coproducts and gave the necessary and sufficient conditions for them to become bialgebras in [20, Proposition 2.2]. In braided monoidal categories, J. Q. Li and Y. H. Xu introduced the smash coproducts and show that if (B, ρ) is an H -comodule bialgebra and H is commutative in the sense of [13,14], the smash coproduct $B_\rho \times H$ is a bialgebra in [6, Theorem1]. In this paper, we study the twisted smash coproducts in a braided monoidal category and give a necessary and sufficient condition for a twisted smash coproduct $A \times_r H$ to be a bialgebra in a braided monoidal category.

A monoidal category consists of a category \mathcal{C} equipped with a functor $\otimes : \mathcal{C} \otimes \mathcal{C} \rightarrow \mathcal{C}$ and functorial isomorphisms $\Phi_{X,Y,Z} : X \otimes (Y \otimes Z) \rightarrow (X \otimes Y) \otimes Z$ for all object X, Y, Z and a unit object I with functorial isomorphisms $l_X : X \rightarrow I \otimes X$, $r_X : X \rightarrow X \otimes I$ for all objects X . The Φ should obey a well-known pentagon coherence identity while the l and r obey triangle identities of compatibility with Φ [8]. We denote $id \otimes \cdots \otimes id$ (n tensor) by id^n .

A quasismmetry or "braiding" c is a collection of functorial isomorphisms $c_{X,Y} : X \otimes Y \rightarrow Y \otimes X$ obeying two hexagon coherence identities. If we suppress writing c explicitly, then these

take the form $c_{X,Y \otimes Z} = c_{X,Z} \circ c_{X,Y}$, $c_{X \otimes Y,Z} = c_{X,Z} \circ c_{Y,Z}$, while further identities such as $c_{X,I} = id = c_{I,Y}$ can be deduced. If $c^2 = id$ then one of the hexagons is superfluous and we have an ordinary symmetric monoidal category or tensor category as in [1]. Categories with braiding were formally introduced into category theory in [4] under the heading “braided monoidal categories”, see also [17,2].

In general an algebra, coalgebra, bialgebra or Hopf algebra being in a braided monoidal category means that the structure maps are morphisms in the category and satisfy their axioms. In what follows, we will use a graphical calculus. All maps are written downwards from top to bottom: a morphism $f : A \otimes B \rightarrow C$ is written as Υ -vertex, suitably labeled, while a morphism $f : A \rightarrow B \otimes C$ is written as \wedge -vertex. Other morphisms too are written as vertices or nodes with inputs and outputs according to the valency of the morphism. The unit object I in the category is suppressed so that a morphism $I \rightarrow A$ has one output but no input and a morphism $A \rightarrow I$ has one input but no output. Finally, c, c^{-1} are written as braid crossings $c_{X,Y} = \times$ and $c_{Y,X}^{-1} = \times$. Functoriality of c, c^{-1} under morphisms means precisely that the vertex of a morphism may be translated through a braid crossing provided no paths are cut. The details can be found in [16,18,5]. Throughout this chapter, we assume that $(\mathcal{C}, \otimes, I, c)$ is a braided monoidal category, $H, A, V \in ob\mathcal{C}$ and that

$$\begin{aligned} \phi : A \rightarrow H \otimes A & , & \psi : A \rightarrow A \otimes H, & \rho : V \rightarrow H \otimes V, \\ m_A : A \otimes A \rightarrow A & , & m_H : H \otimes H \rightarrow H, \\ \Delta_A : A \rightarrow A \otimes A & , & \Delta_H : H \rightarrow H \otimes H, \\ \eta_A : I \rightarrow A & , & \eta_H : I \rightarrow H, \\ \epsilon_A : A \rightarrow I & , & \epsilon_H : H \rightarrow I, \\ s_A : A \rightarrow A & , & s_H : H \rightarrow H, \\ s_A^{-1} : A \rightarrow A & , & s_H^{-1} : H \rightarrow H \end{aligned}$$

are morphisms in \mathcal{C} .

Definition 1.1. H is called a Hopf algebra in \mathcal{C} if the following conditions hold:

$$\begin{array}{l} (1) \\ \text{a} \end{array} \quad \begin{array}{c} H \quad H \quad H \\ \cup \quad \cup \\ \cup \\ H \end{array} = \begin{array}{c} H \quad H \quad H \\ \cup \quad \cup \\ \cup \\ H \end{array} \quad \begin{array}{l} \text{b} \end{array} \quad \begin{array}{c} \eta_H \quad H \\ \cup \\ H \end{array} = \begin{array}{c} H \\ | \\ H \end{array} = \begin{array}{c} H \quad \eta_H \\ \cup \\ H \end{array} \\ (2) \\ \text{a} \end{array} \quad \begin{array}{c} H \\ | \\ \cup \quad \cup \\ H \quad H \quad H \end{array} = \begin{array}{c} H \\ | \\ \cup \quad \cup \\ H \quad H \quad H \end{array} \quad \begin{array}{l} \text{b} \end{array} \quad \begin{array}{c} H \\ | \\ \cup \\ \epsilon_H \quad H \end{array} = \begin{array}{c} H \\ | \\ H \end{array} = \begin{array}{c} H \\ | \\ \cup \\ H \quad \epsilon_H \end{array}$$

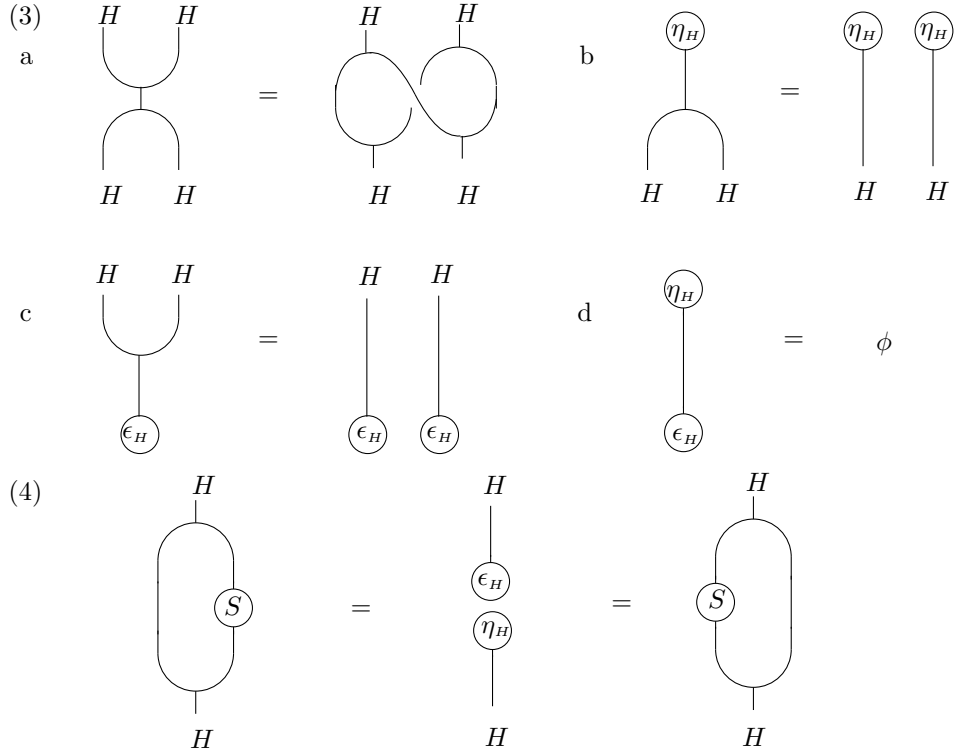

Fig.1.

Definition 1.2. Let H be a Hopf algebra in \mathcal{C} and A a coalgebra in \mathcal{C} .

(i) (A, ϕ) is a left H -comodule in \mathcal{C} if the following conditions are satisfied:

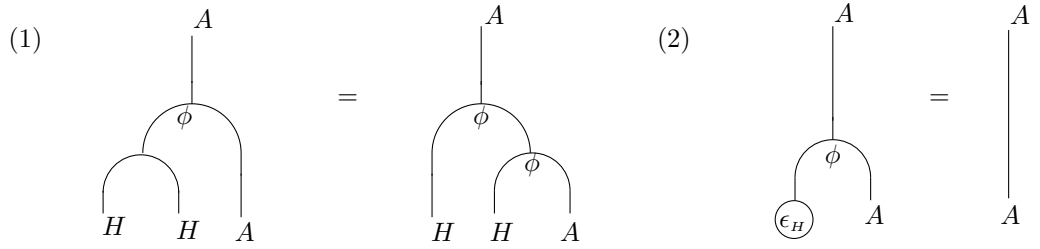

Fig.2.

(ii) (A, ψ) is a right H -comodule in \mathcal{C} if the following conditions are satisfied:

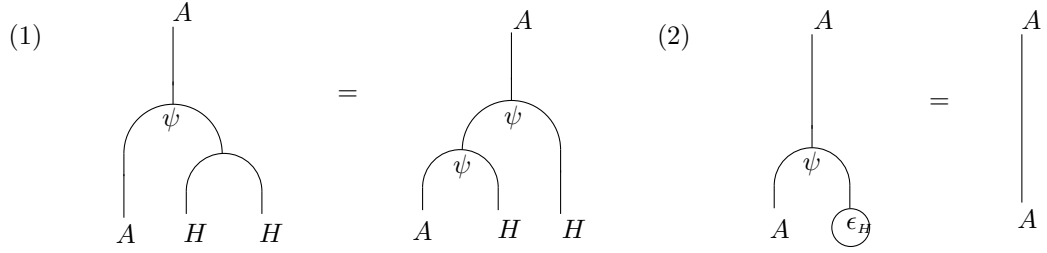

Fig.3.

(iii) (A, ϕ) is a left H -comodule in \mathcal{C} and (A, ψ) a right H -comodule in \mathcal{C} . (A, ϕ, ψ) is an H -bicomodule in \mathcal{C} if the following conditions are satisfied:

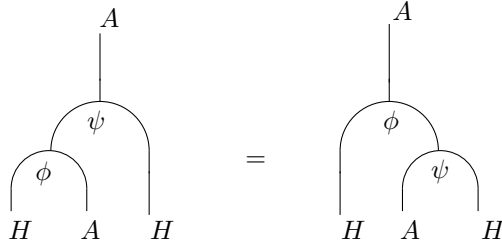

Fig.4.

Definition 1.3. Let H be a Hopf algebra in \mathcal{C} and (A, ϕ) a left H -comodule in \mathcal{C} .

(i) A is called a left H -comodule algebra in \mathcal{C} if it is an algebra in \mathcal{C} and the following conditions hold:

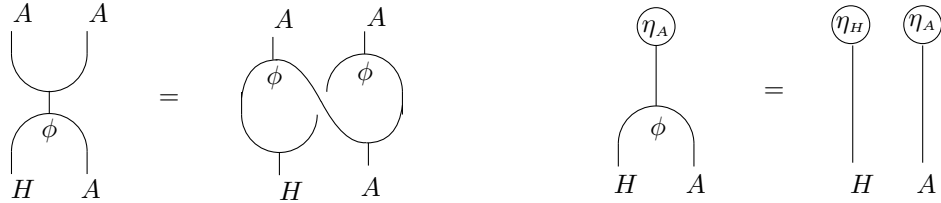

Fig.5.

(ii) A is called a left H -comodule coalgebra in \mathcal{C} if it is a coalgebra in \mathcal{C} and the following conditions hold:

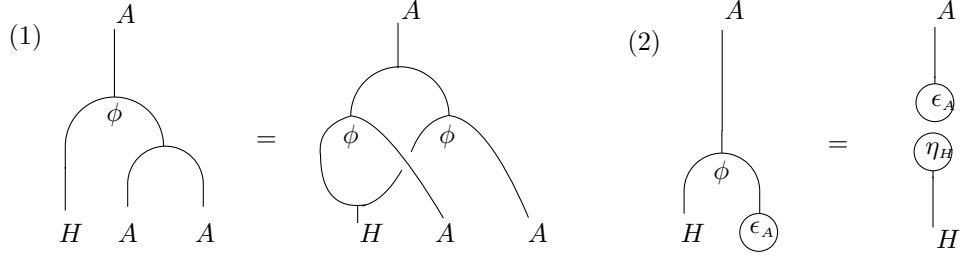

Fig.6.

Definition 1.4. Let H be a Hopf algebra in \mathcal{C} and (A, ψ) a right H -comodule in \mathcal{C} . A is called a right H -comodule coalgebra in \mathcal{C} if the following conditions hold:

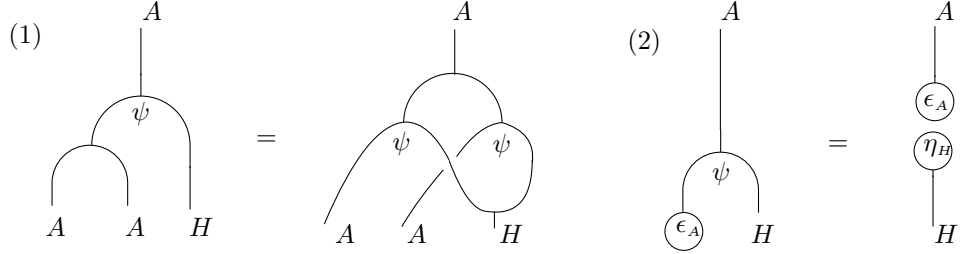

Fig.7.

Definition 1.5. Let H be a Hopf algebra in \mathcal{C} and A a coalgebra in \mathcal{C} . A is called an H -bicomodule coalgebra in \mathcal{C} if the following conditions hold:

(i) (A, ϕ, ψ) is an H -bicomodule in \mathcal{C} .

(ii) A is not only left H -comodule coalgebra with the left comodule coaction ϕ in \mathcal{C} but also right H -comodule coalgebra with the right comodule coaction ψ in \mathcal{C} .

Definition 1.6. [13,14] Let H be a bialgebra in the braided monoidal category \mathcal{C} . We say that $m^{op} : H \otimes H \rightarrow H$ is an opposite multiplication for H if it makes H into a bialgebra in \mathcal{C} and all left H -comodule V (with left comodule coaction ρ) in \mathcal{C} such that

$$(m^{op} \otimes id) \circ (id \otimes \rho) = (m \otimes id) \circ (id \otimes c_{V,H}) \circ (id \otimes c_{H,V}) \circ (c_{H,H} \otimes id) \circ (id \otimes \rho).$$

Definition 1.7. The bialgebra H in \mathcal{C} is called braided commutative if $m^{op} = m$.

Definition 1.8. [9,15] If H is a Hopf algebra in \mathcal{C} , then the antipode, denoted by S , is an anti-(co)algebra morphism by Fig8.(1) and Fig8.(2) respectively:

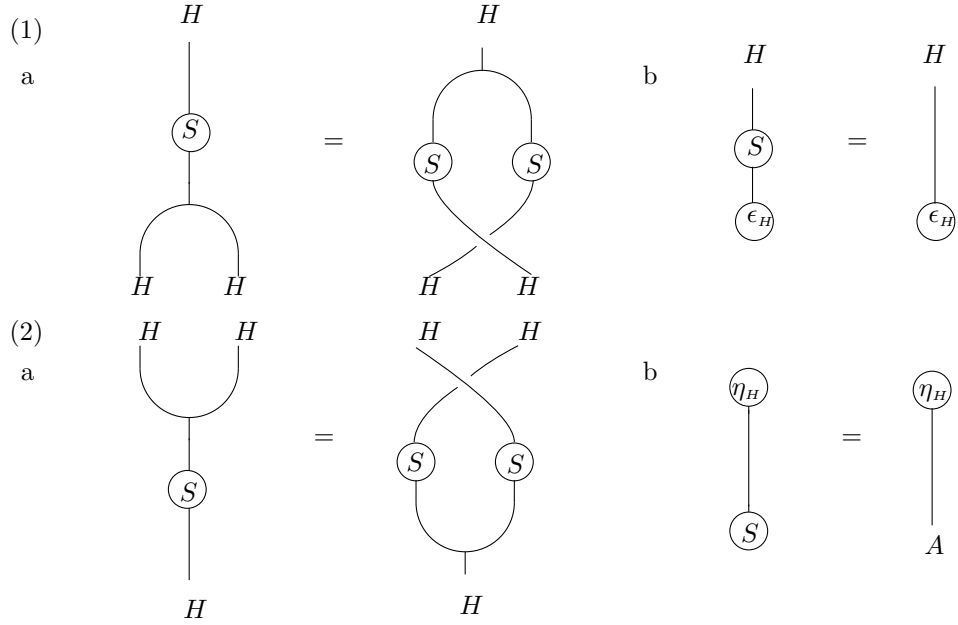

Fig.8.

Proposition 1.9. *Let H be a Hopf algebra in \mathcal{C} and A an H -bicomodule coalgebra in \mathcal{C} . Then the object $A \otimes H$ becomes a coalgebra in \mathcal{C} by the comultiplication*

$$\begin{aligned} \Delta_{A \times_r H} = & (id \otimes m \otimes id^2) \circ (id^2 \otimes m \otimes id^2) \circ (id^3 \otimes c_{A,H} \otimes id) \\ & \circ (id^4 \otimes s \otimes id) \circ (id^3 \otimes \psi \otimes id) \circ (id^2 \otimes c_{A,H} \otimes id) < 1 > \\ & \circ (id \otimes \phi \otimes id^2) \circ (\Delta_A \otimes \Delta_H) \end{aligned}$$

and the counit $\epsilon_A \otimes \epsilon_H$, denoted by $B = A \times_r H$.

In graphical notation $< 1 >$ is depicted as follows:

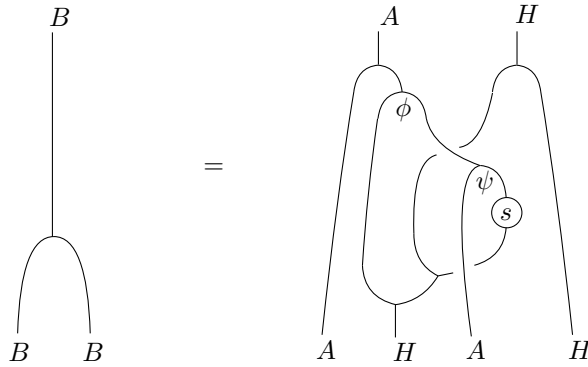
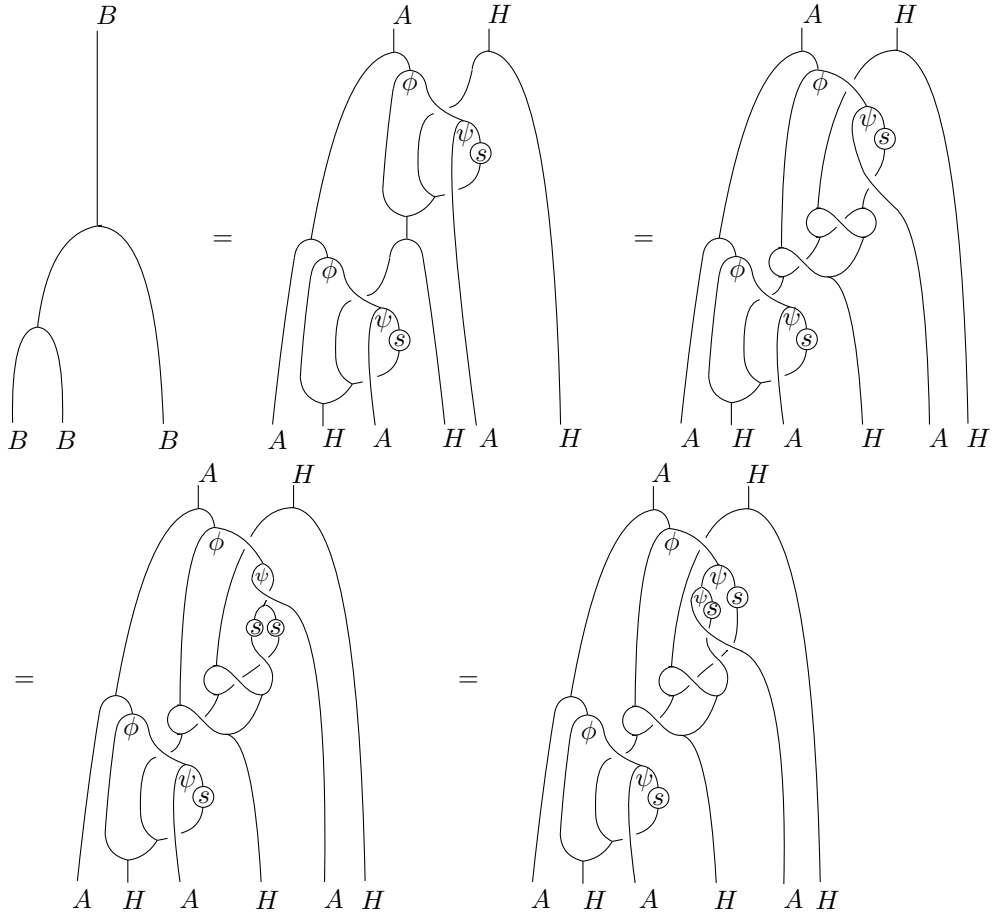
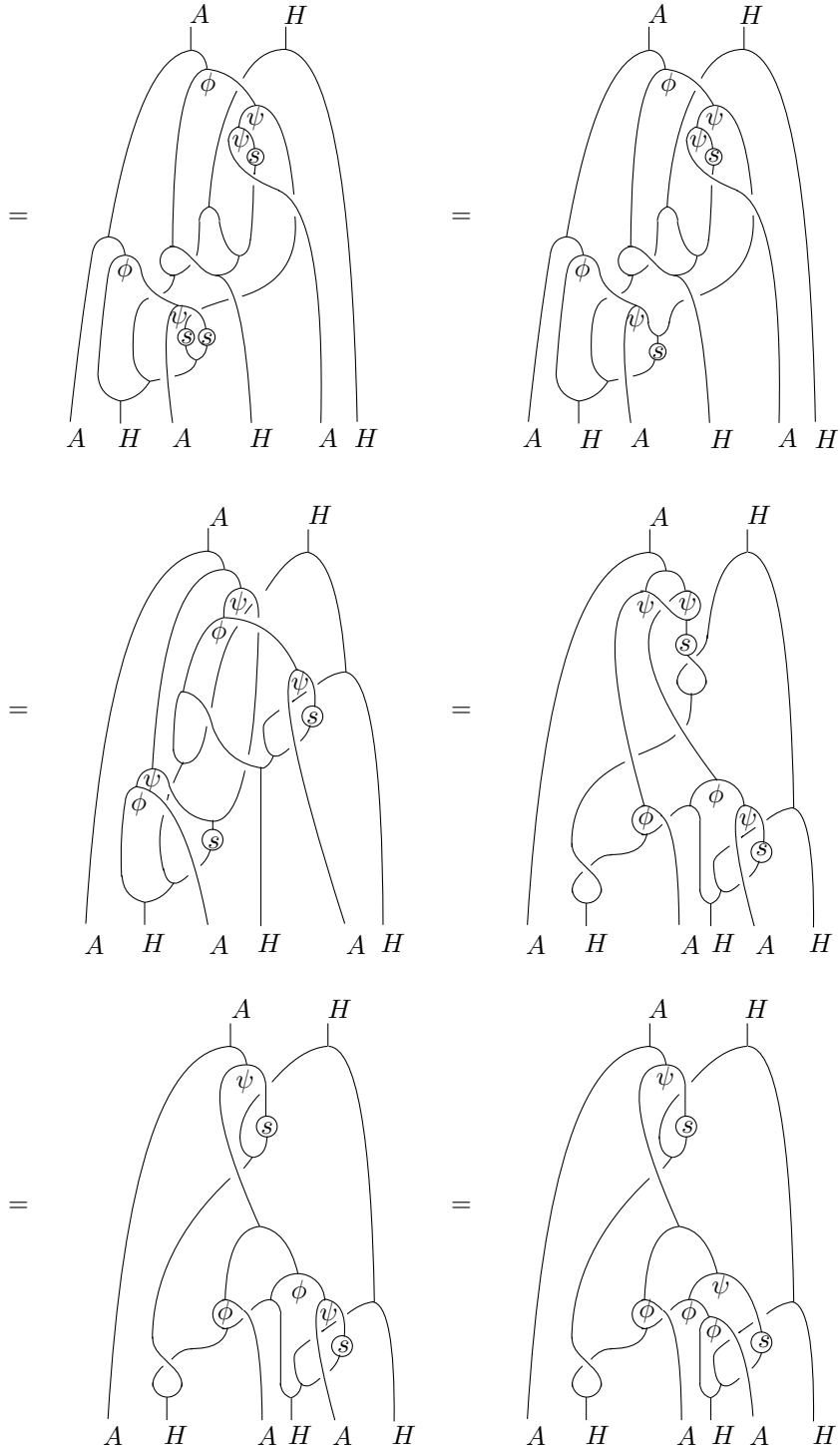

Fig.9.

Proof. The proof is given in Fig.10. The first and last equality follow by the definitions of the comultiplication in $B = A \times_r H$. The second uses Fig.1(3)a. The third follows by Fig.8(1)a.

The fourth by Fig.3(1) and functoriality. The fifth uses associativity of m_H and functoriality. The sixth follows by Fig.8(2)a. The seventh uses Fig.4, functoriality and coassociativity of A and H . The eighth uses associativity of m_H and functoriality. The ninth follows by Fig.7(1) and functoriality. The tenth follows by Fig.4 and Fig.2(1). The eleventh follows by Fig.4 and Fig.6(1). The twelfth uses functoriality. The thirteenth uses Fig.4 and functoriality to arrange the diagram for the last step. Thus the comultiplication is coassociative.





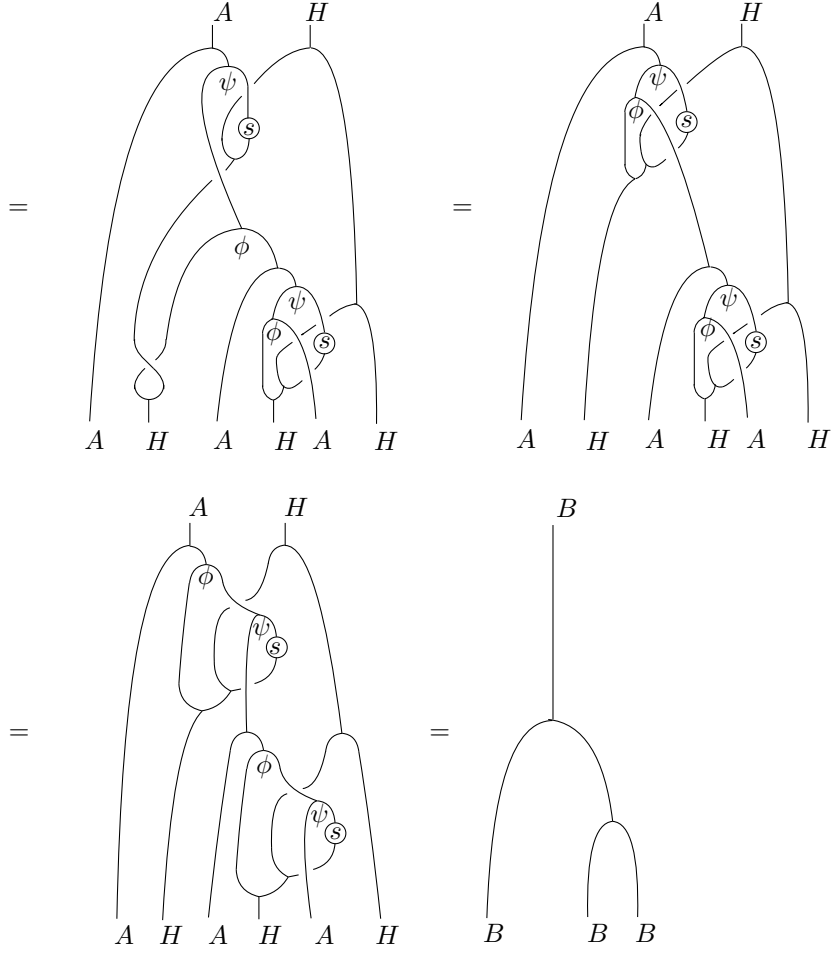

Fig.10.

It is obvious that $\epsilon_A \otimes \epsilon_H$ is counit element. This completes the proof. \square

For convenience, the coalgebra in Proposition 1.9 is called a right twisted smash coproduct in \mathcal{C} . For the sake of the following Example 1.10, the right twisted smash coproduct is regarded as a smash coproduct which is twisted by the right H -comodule coaction.

Example 1.10. Let A be a left H -comodule coalgebra in \mathcal{C} with the trivial right H -comodule coaction in \mathcal{C} , then A is an H -bicomodule coalgebra in \mathcal{C} . A simple proof shows that $A \times_r H$ is actually a smash coproduct $A \times H$. This implies that the smash coproduct in \mathcal{C} is a special case of the right twisted smash coproduct.

Similarly, let A be an H -bicomodule coalgebra in \mathcal{C} . A left twisted smash coproduct $B' = H_l \times A$ is defined as a vector space $H \otimes A$ with comultiplication

$$\begin{aligned} \Delta_{H_l \times A} = & (id^2 \otimes m \otimes id) \circ (id^2 \otimes m \otimes id^2) \circ (id \otimes c_{H,A} \otimes id^3) \\ & \circ (id \otimes s \otimes id^4) \circ (id \otimes \phi \otimes id^3) \circ (id \otimes c_{H,A} \otimes id^2) &< 2 > \\ & \circ (id^2 \otimes \psi \otimes id) \circ (\Delta_H \otimes \Delta_A) \end{aligned}$$

and the counit $\epsilon_H \otimes \epsilon_A$. We obtain that $B' = H_l \times A$ is a coassociative coalgebra by a similar method to that in the proof of Proposition 1.9.

In graphical notation $\langle 2 \rangle$ is depicted as follows:

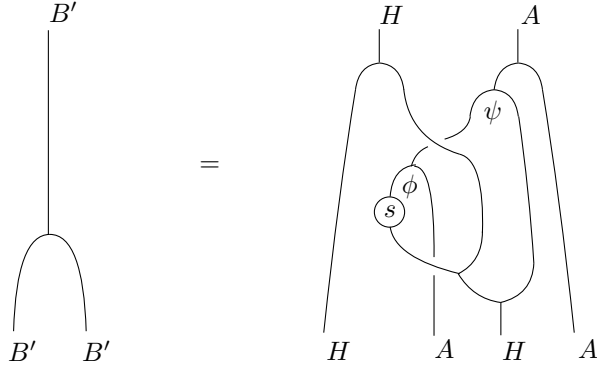

Fig.11.

In this paper, we mainly study the structure of right twisted smash coproducts in \mathcal{C} .

Define $\pi_H : A \times_r H \rightarrow H$ and $\pi_A : A \times_r H \rightarrow A$ by $\pi_H = \epsilon_A \otimes id_H$ and $\pi_A = id_A \otimes \epsilon_H$. Then one can easily check that π_A and π_H are coalgebra morphism in \mathcal{C} .

Proposition 1.11. *The following two equations are satisfied:*

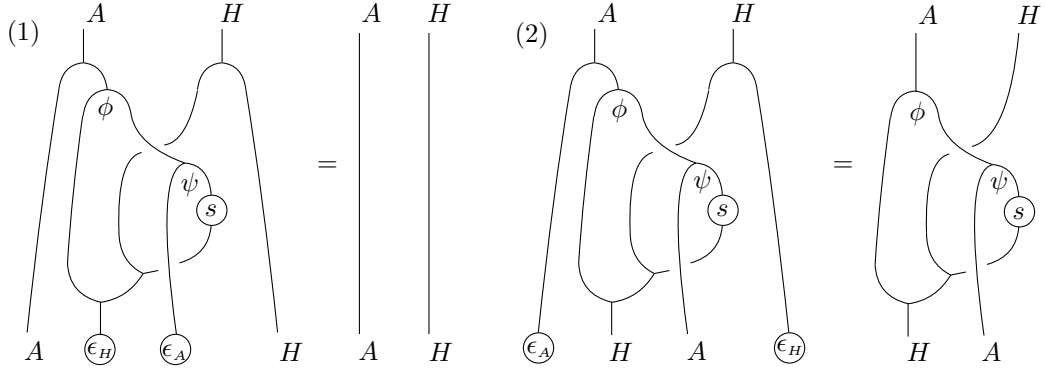

Fig.12.

Proof. It is obvious. □

2. The bialgebra $A \times_r H$ in \mathcal{C}

Now we give the main theorem of this section.

Theorem 2.1. *Let A be a bialgebra and an H -bicomodule coalgebra in \mathcal{C} .*

(i) The right twisted smash coproduct coalgebra $B = A \times_r H$ in \mathcal{C} equipped with the tensor product algebra structure in \mathcal{C} makes $B = A \times_r H$ into a bialgebra, if the following conditions hold:

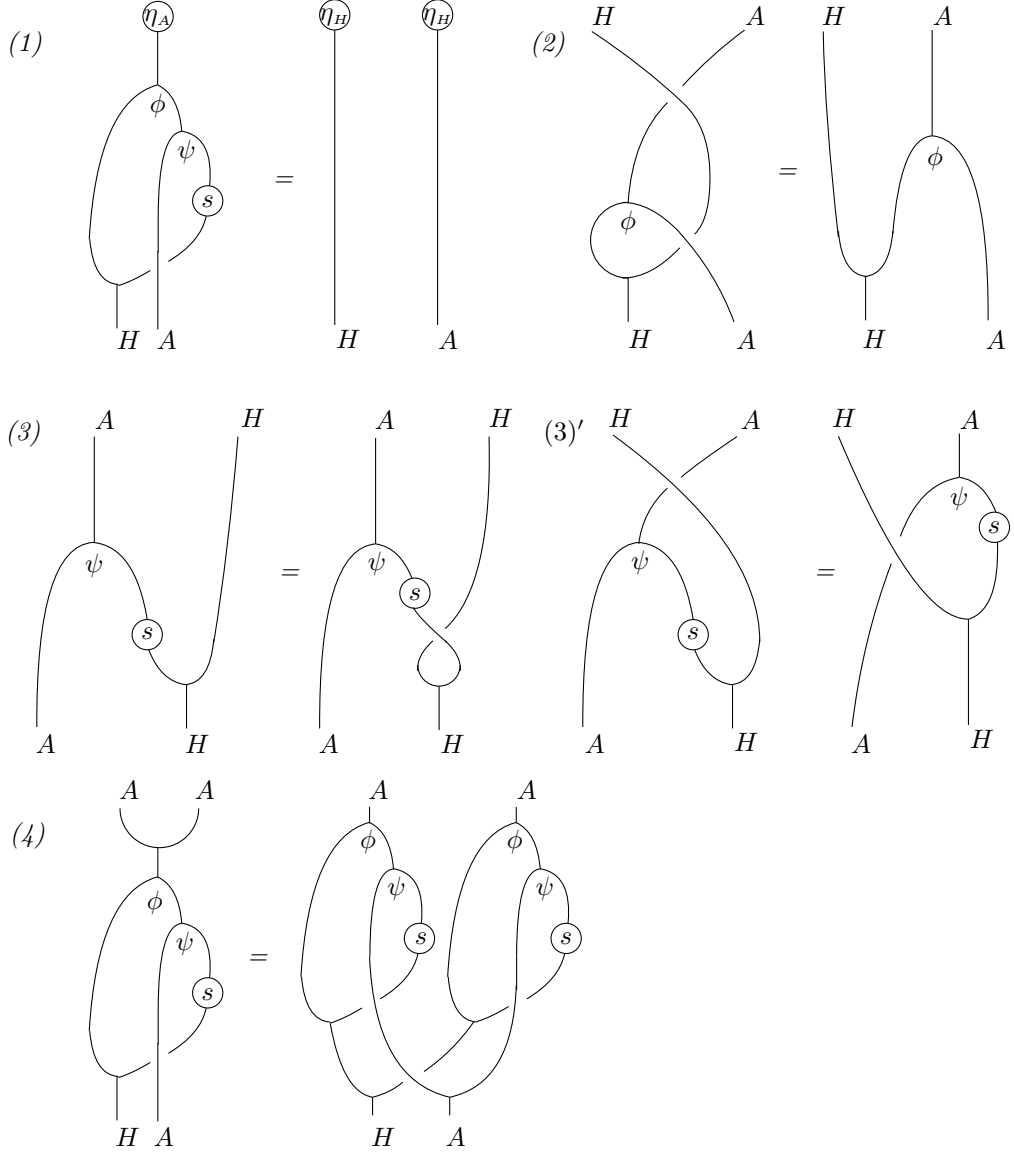
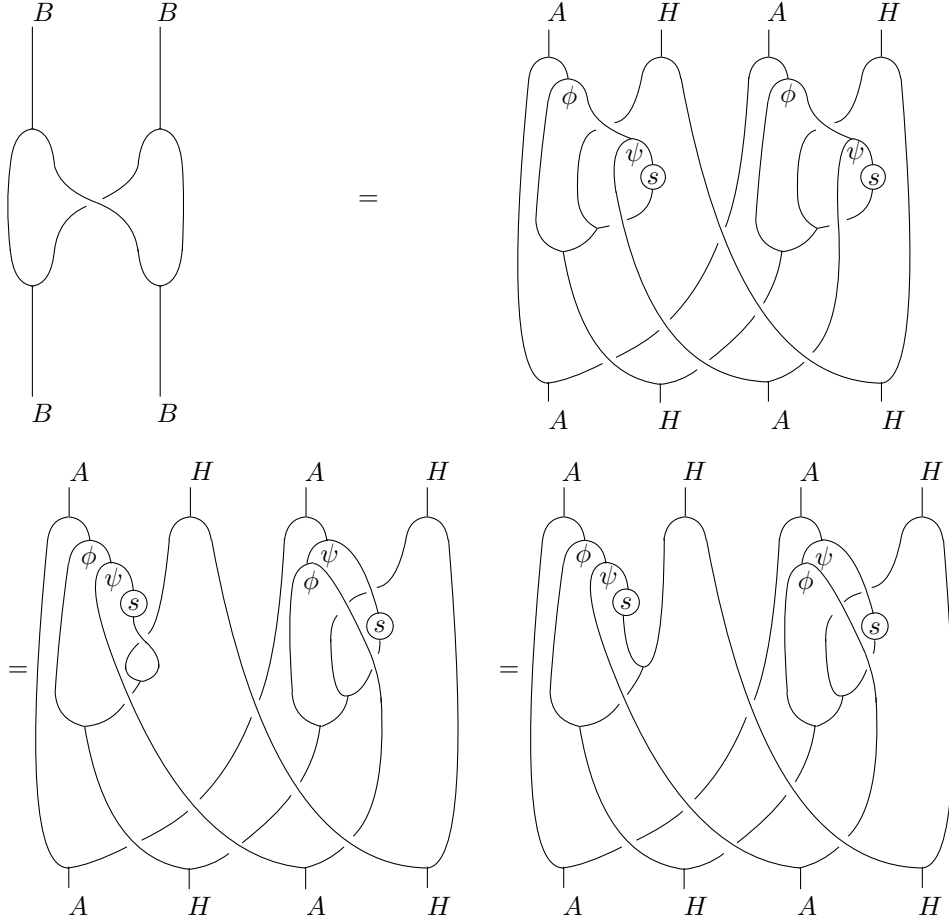

Fig.13.

(ii) Assume that $\psi \circ \eta_A = \eta_A \otimes \eta_H$, then the right twisted smash coproduct coalgebra $A \times_r H$ in \mathcal{C} equipped with the tensor product algebra structure in \mathcal{C} makes $A \times_r H$ into a bialgebra in \mathcal{C} if and only if conditions (1), (2), (3), (3)' and (4) in (i) hold.

Proof. (i) We show the proof in Fig.14. The first and last equality follow by the definitions of the comultiplication in $B = A \times_r H$. The second follows by Fig.4 and functoriality. The third

follows by Fig.13(3). The fourth, the seventh, the ninth and the thirteenth uses associativity of m_H and functoriality. The fifth follows by Fig.13(2). The sixth uses functoriality, Fig.3, and Fig.13(3). The eighth follows by Fig.13(3)'. The tenth follows by Fig.13(4). The eleventh uses associativity of m_H , functoriality and Fig.13(3). The twelfth uses associativity of m_H and Fig.13(3). The fourteenth uses Fig.1(3)a. This show that $\Delta_{A \times_r H}$ is an algebra morphism in \mathcal{C} with respect to the comultiplication on $A \times_r H$ and tensor product algebra structure on $A \times_r H$ in \mathcal{C} .



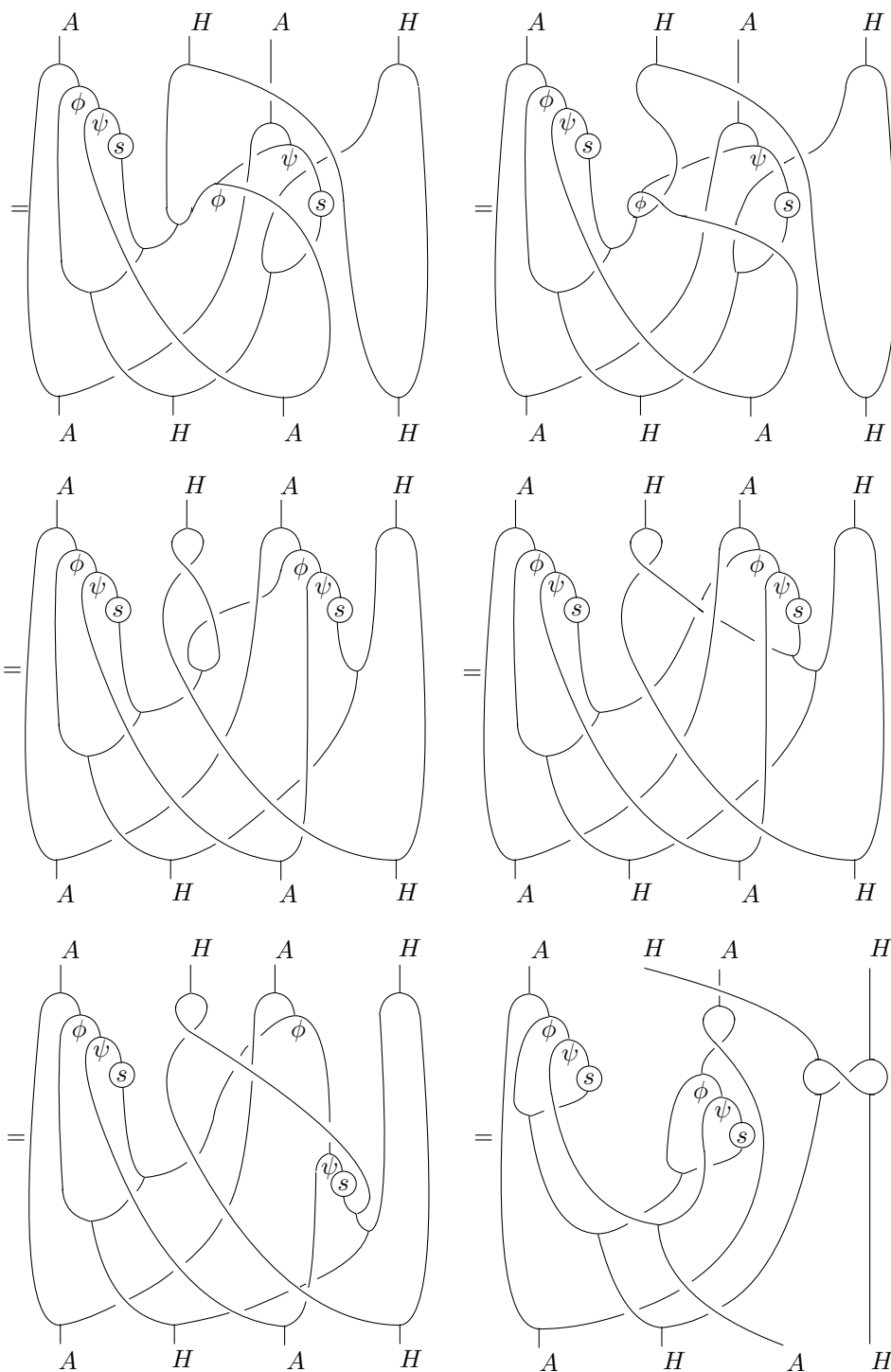

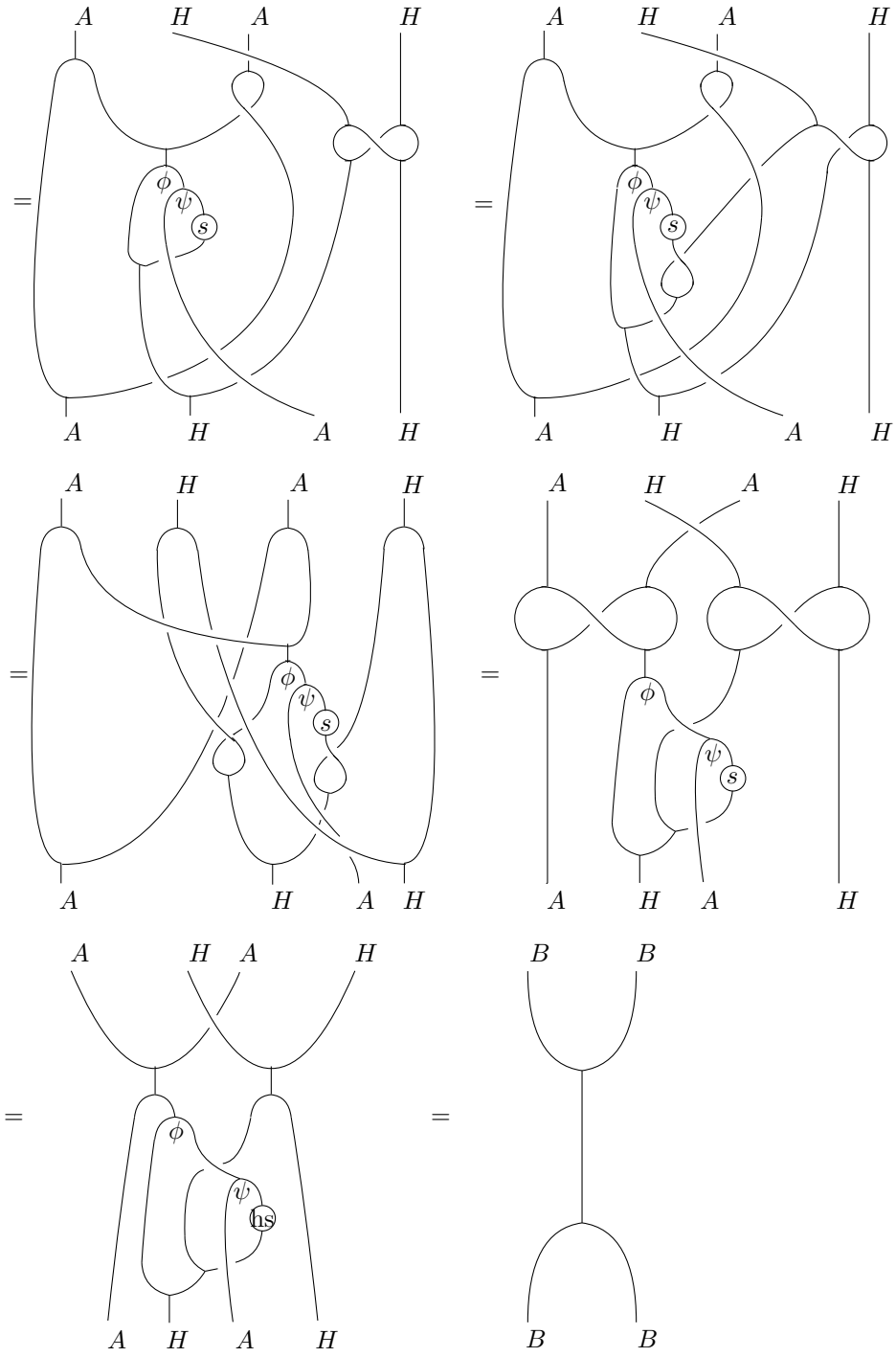
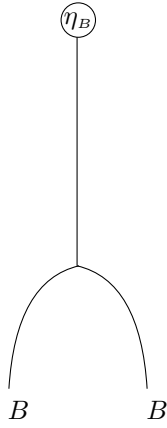

Fig.14.

It is not hard to verify that $\epsilon_{A \times_r H} = \epsilon_A \otimes \epsilon_H$ is an algebra morphism in \mathcal{C} by (1). Thus (i) holds.

(ii) “ \Leftarrow ” see (i).

“ \Rightarrow ” Let $B = A \times_r H$ be a bialgebra, we have that



=

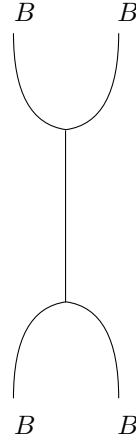
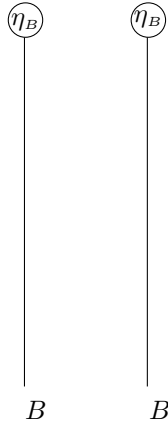

=

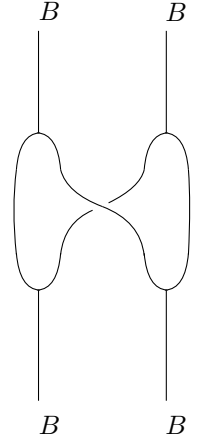

Fig.15.

Fig.16.

By Fig.15, we have that

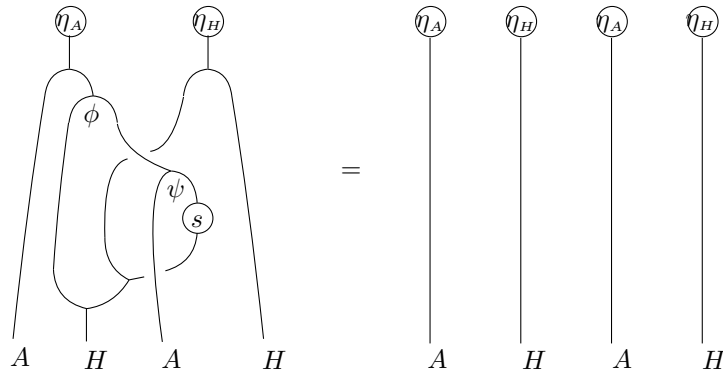

Fig.17.

Applying $\epsilon_A \otimes id \otimes id \otimes \epsilon_H$ to the bottom of relation Fig.17, we obtain(1).

By Fig.16, we have that

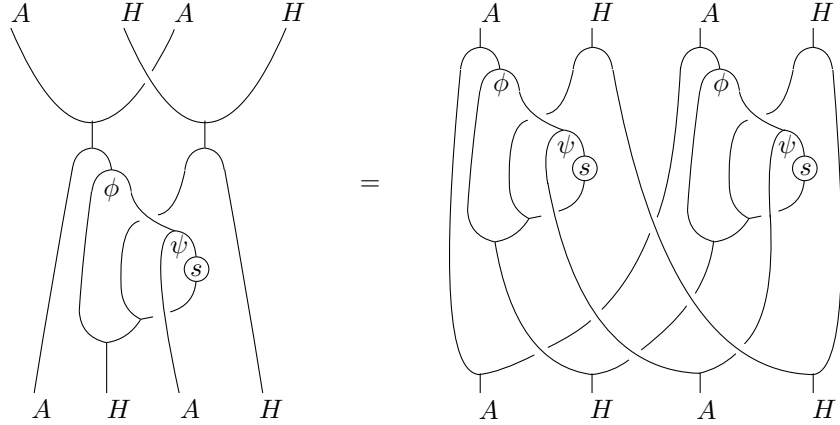

Fig.18.

Applying $\epsilon_A \otimes id \otimes id \otimes \epsilon_H$ to the bottom of relation Fig.18, we obtain

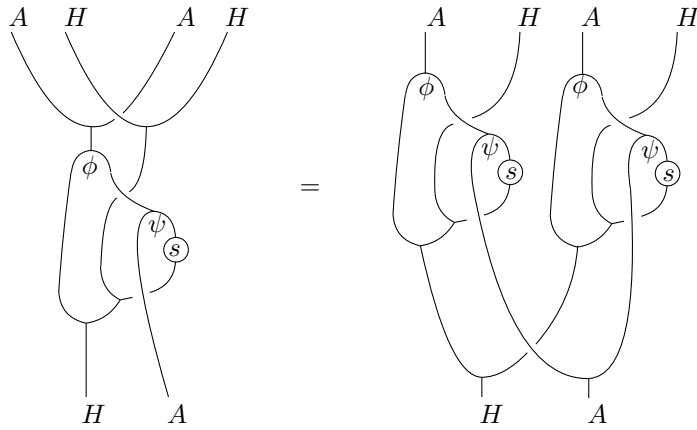

Fig.19.

Applying $id \otimes \eta_H \otimes id \otimes \eta_H$ to the top of relation Fig.19, we obtain (4).

Using the fact $\psi \circ \eta_A = \eta_A \otimes \eta_H$ and (1), we have $\phi \circ \eta_A = \eta_H \otimes \eta_A$. Hence we obtain $(id \otimes \psi) \circ \phi \circ \eta_A = \eta_H \otimes \eta_A \otimes \eta_H$. Applying $\eta_A \otimes id \otimes id \otimes id$ to the top of relation Fig.19 and using $(id \otimes \psi) \circ \phi \circ \eta_A = \eta_H \otimes \eta_A \otimes \eta_H$, we obtain

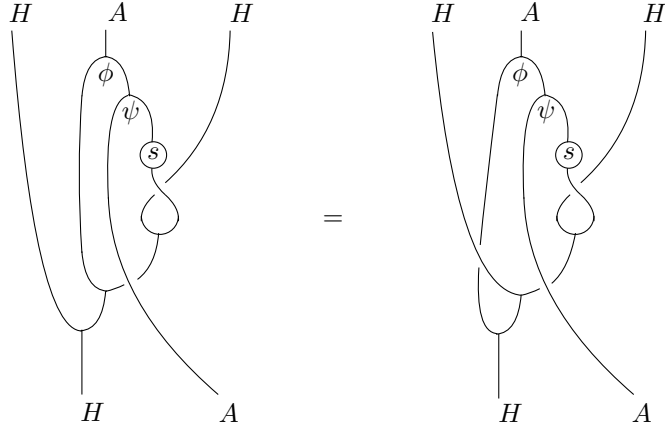

Fig.20.

Applying $(id \otimes id \otimes s^2) \circ (id \otimes \psi)$ to the top of relation Fig.20, we obtain (2).

Similarly, applying $id \otimes id \otimes \eta_A \otimes id$ to the top of relation Fig.19 and using (1), we have

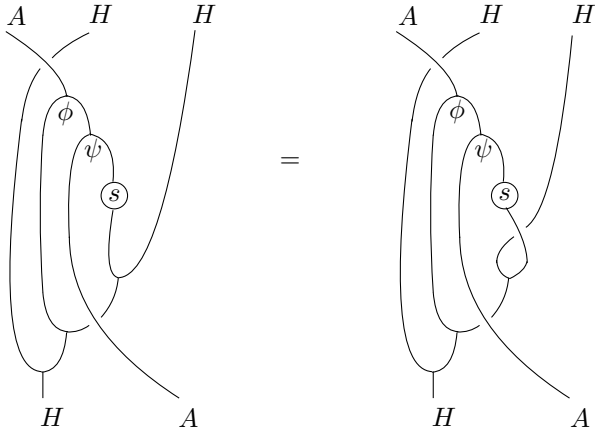

Fig.21.

i.e.

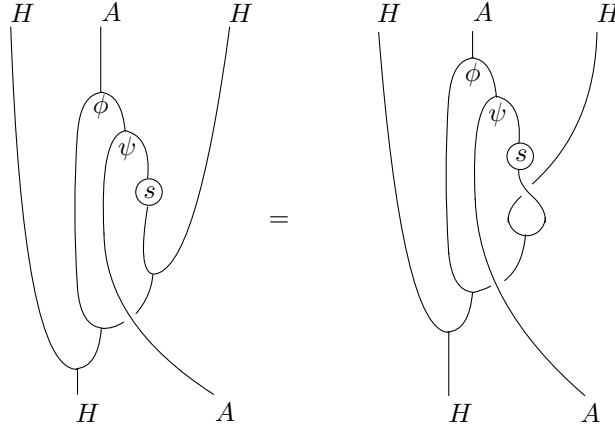

Fig.22.

Applying $(s \otimes id \otimes id) \circ (\phi \otimes id)$ to the top of relation Fig.22, we obtain (3), i.e. (3)'. This completes the proof. \square

Proposition 2.2. *In the situation of the Theorem 2.1, If A is actually a Hopf algebra in \mathcal{C} then so is $A \times_r H$. The antipode on $A \otimes H$ is defined by*

$$s_{A \times_r H} = c_{A,H} \circ (s_H \otimes s_A) \circ (m_H \otimes id) \circ (id \otimes m_H \otimes id) \circ (id^2 \otimes c_{A,H}) \circ (id^3 \otimes s_H) \circ (id^2 \otimes \psi) \circ (id \otimes c_{A,H}) \circ (\phi \otimes id) \tag{3}$$

In graphical notation $\langle 3 \rangle$ is depicted as follows:

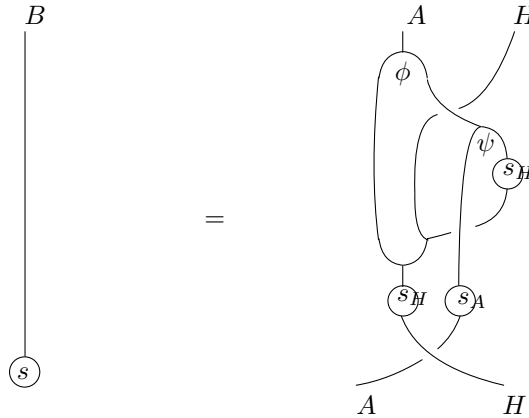
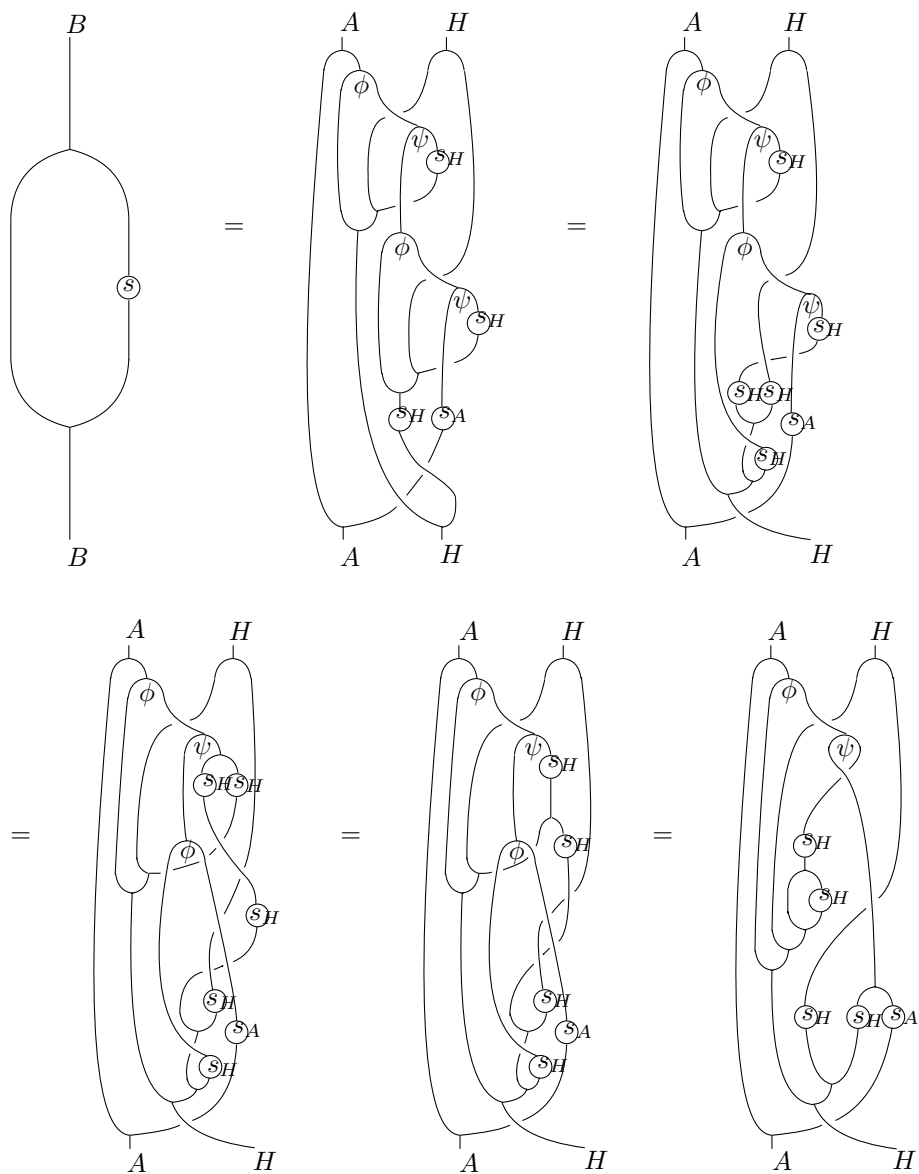

Fig.23.

Proof. We prove the theorem in Fig.24. The first equality follows by the definitions of s_B and the comultiplication in $B = A \times_r H$. The second uses functoriality and Fig.8(2)a. The third uses functoriality, Fig.4, and Fig.3(1). The fourth follows by Fig.8(1)a. The fifth uses associativity of m_H and functoriality. The sixth uses the antipode axiom as in Fig.1(4), Fig.8(1)b, Fig.1(1)b,

Fig.3(2). and functoriality. The seventh uses associativity of m_H . The eighth uses the antipode axiom as in fig.1(4) and Fig.1(1)b. The ninth follows by Fig.2(1) and functoriality. The tenth follows by Fig.1(4) and Fig.2(2). The last follows by Fig.1(4) .



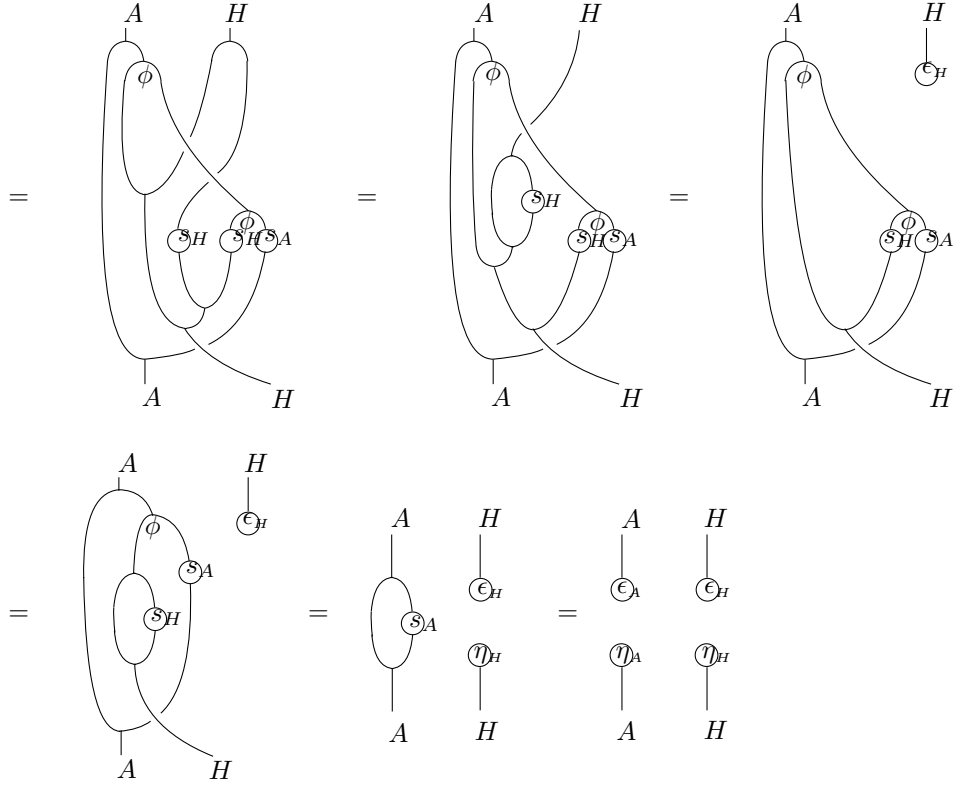
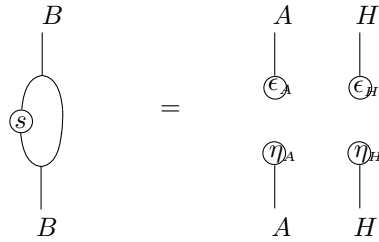

fig.24.

Similarly, the following equation holds:



This completes the proof. □

If ψ is trivial in \mathcal{C} , then (3) holds and conditions (1) and (4) in Theorem 2.1 are satisfied if and only if A is a left H -comodule algebra in \mathcal{C} . Thus we have:

Corollary 2.3. *Let A be a bialgebra and a left H -comodule coalgebra in \mathcal{C} . Then the smash coproduct coalgebra $A \times H$ in \mathcal{C} equipped with the tensor product algebra structure in \mathcal{C} makes $A \times H$ into a bialgebra in \mathcal{C} if and only if A is a left H -comodule algebra in \mathcal{C} and (2) holds.*

By Corollary 2.3 we have the following result.

Corollary 2.4. [6, Theorem 1, Theorem 2] *Let H be a commutative Hopf algebra in \mathcal{C} in the sense of Definition 1.7 with respect to A as an H -comodule bialgebra in \mathcal{C} . Then the tensor product algebra structure on $A \times H$ in \mathcal{C} equipped with the smash coproduct structure in \mathcal{C} makes $A \times H$ into a bialgebra.*

Furthermore, if A is a Hopf algebra in \mathcal{C} , then $A \times H$ is also a Hopf algebra in \mathcal{C} with the $s_{A \times H}$ defined by

$$s_{A \times H} = (s_A \otimes s_H) \circ c_{H, A} \circ (m_H \otimes id) \circ (id \otimes c_{A, H}) \circ (\phi \otimes id)$$

Acknowledgment. The authors would like to thank the referee for the valuable suggestions and comments.

References

- [1] P. Deligne and J. S. Milne, *Tannakian Categories*, Lecture Notes in Math., Vol. 900, Springer, 1982.
- [2] P. Freyd and D. Yetter, *Braided compact closed categories with applications to low dimensional topology*, Adv. Math., 77 (1989), 156-182.
- [3] R. G. Heyneman and M. E. Sweedler, *Affine Hopf algebra, I.*, J. Algebra, 13 (1969), 192-241.
- [4] A. Joyal and R. Street, *Braided monoidal categories*, Adv. Math., 102 (1993), 20-78.
- [5] C. Kassel, *Quantum Groups*, Springer-Verlag, New York, 1995.
- [6] J. Q. Li and Y. H. Xu, *Smash coproduct and braided groups in braided monoidal category*, Science in China, Series A, (1997) 1121-1128.
- [7] V. Lyubashenko, *Tangles and Hopf algebras in braided tensor categories*, J. Pure Appl. Algebra, 98 (1995), 245-278.
- [8] S. Mac Lane, *Categories for the Working Mathematician*, GTM Vol. 5, Springer, Berlin/New York, 1971.
- [9] S. Majid, *Algebras and Hopf algebras in braided categories*, Advances in Hopf algebras (Chicago, IL, 1992), 55-105, Lecture Notes in Pure and Appl. Math., 158, Dekker, New York, 1994.
- [10] S. Majid, *Foundations of Quantum Group Theory*, Cambridge University Press, Cambridge, 1995.
- [11] S. Majid and M. J. Rodríguez-Plaza, *Random walk and the heat equation on superspace and anyspace*, J. Math. Phys., 35(7) (1994), 3753-3760.
- [12] S. Majid, *Beyond supersymmetry and quantum symmetry (an introduction to braided groups and braided matrices)*, (Proceeding of the 5th Nakai workshop, Tianjin, China), Quantum Groups, Integrable Statistical Models and Knot Theory, 1992, edited by M. L. Ge and H.J. De Vega, World Scientific, Singapore, 1993, 231-282.
- [13] S. Majid, *Braided groups and algebraic quantum field theories*, Lett. Math. Phys., 22 (1991), 167-175.
- [14] S. Majid, *Some physical applications of category theory*, In Proceeding of the 19th DGM, Rapallo, 1990, Lecture Notes in physics, Vol. 375 (Springer, Berlin, 1991), 131-142.
- [15] S. Majid, *Braided groups*, J. Pure Appl. Algebra, 86 (1993), 187-221.

- [16] S. Majid, *Transmutation theory and rank for quantum braided groups*, Math. Proc. Camb. Phil. Soc., 113 (1993), 45-70.
- [17] S. Majid, *More examples of bicrossproduct and double cross product Hopf algebras*, Israel J. Math., 72 (1990), 133-148.
- [18] S. Majid, *Cross products by braided groups and Bosonization*, J. Algebra, 163 (1994), 165-190.
- [19] R. K. Molnar, *Semi-direct products of Hopf algebras*, J. Algebra, 47 (1977), 29-51.
- [20] S. H. Wang and J. Q. Li, *On twisted smash product for bimodule algebras and the Drinfeld double*, Comm. Algebra, 26(8) (1998), 2435-2444.

Wenzheng Zhao
College of Mathematics and Information Science
Henan Normal University
453007 Xixiang, P. R. China
e-mail: zwz@henannu.edu.cn

Shengjie Gao
College of Mathematics and Information Science
Henan Normal University
453007 Xixiang, P. R. China
e-mail: shengjie9@sina.com

Tianshui Ma
College of Mathematics and Information Science
Henan Normal University
453007 Xixiang, P. R. China
e-mail: mtianshui@yahoo.com.cn